

# Canon



CORPORATE SOLUTIONS



Color  
imagerUNNER®  
C 2 5 5 0

meap  
POWERED BY I

## CORPORATE SOLUTIONS

**THE COLOR imageRUNNER C2550 DEVICE – BIG FEATURES, SMALL FOOTPRINT, AND IMPRESSIVE COLOR. EVERY DAY.**

**RUN smart color in the office**

Achieving high productivity from your office multifunction system becomes a reality when your office is powered by the Canon Color imageRUNNER C2550 device. With robust functionality, advanced print engine technology, superior paper handling, compact footprint, and internal finishing options, it's the ideal solution for business performance.

The Color imageRUNNER C2550 device delivers output at speeds of up to 25/23 ppm (letter) in monochrome and brilliant color, respectively. And with Canon's Color RAPID Fusing System using QF (Quick Fixing) Color Toner, you'll realize short warm-up and first-copy-out times as well as low energy consumption.

The Color imageRUNNER C2550 device includes a standard memory capacity of up to 1.5GB, an 80GB hard drive, and Canon's innovative MEAP® (Multifunctional Embedded Application Platform) technology for customized workflows. The device also enables efficient document distribution with Canon's Color Universal Send technology as standard, providing simultaneous dissemination of information to multiple locations, across the hall or around the globe.

Function	Color imageRUNNER C2550
Copy	Standard
Mail Box	Standard
Print	Standard: UFR II Optional: PCL and PostScript® Emulation*
Scan	Standard: Color Network ScanGear
Color Universal Send	Standard: Color Universal Send Optional: Universal Send PDF Advanced Feature-Set** Optional: Universal Send PDF Security Feature-Set***
Super G3 Fax	Optional: Single-Line or Multi-Line
Web Access	Optional
MEAP	Standard

\* PS Printer Kit-Q3 option requires the PCL Printer Kit-Q3 option; also requires 512MB RAM.

\*\* Universal Send PDF Advanced Feature-Set includes PDF High Compression, Searchable PDF, and Trace & Smooth PDF modes.

\*\*\* Universal Send PDF Security Feature-Set includes Digital Device Signature and Encrypted PDF modes.

## THE COMPACT DEVICE WITH EVERYTHING YOU NEED TO SUCCEED

### Canon imageCHIP System Architecture

- imageCHIP architecture provides more speed and power for greater productivity
- Up to 1.5GB RAM and 80GB HDD
- Dedicated dual processor design
- Mail Box: local archival solution
- Remote UI device management



### Efficient Speeds

- Up to 25 ppm (black and white); up to 23 ppm (color) printing
- Quick 38-second warm-up time
- Fast First-Copy-Out times: B/W: 5.9 seconds; Color: 8.9 seconds
- Optional 50-sheet DADF capable of capturing up to 44 ipm

### Reliable Consumables and Supplies

- Individual OPC Drum units
- Easy-to-replace Set-On Toner cartridges
- Oil-Free Quick Fixing (QF) color toners



### High-Quality Print Performance

- Standard UFR II print controller
- Optional PCL and PostScript emulation support
- Optional 1200-dpi printing for all PDLs

### Compact Internal Productivity

- Finisher
  - Single output tray with 500-sheet capacity
  - Up to 50-sheet corner and double stapling
- Inner 2-Way Tray
  - Two output trays with 350-sheet capacity

### Accessibility Options

- Voice Operation Kit
- Remote Operators Software Kit
- ADF Access Handle
- Braille Label Kit



### Superior Paper-Handling

- Up to 4,950-sheet paper capacity
- 50-sheet Bypass Tray
- Up to 110 lb. Index media weights
- Up to 12" x 18" media sizes\*



\* Up to legal-sized media available in top cassette.  
Device shown with optional DADF-L1, Finisher-Z1, and Cassette Feeding Unit-Y3.

## HIGH QUALITY AND PRODUCTIVITY

### The features you want, the performance you need

The Color imageRUNNER C2550 device delivers the powerful performance and rich functionality that your office needs, all in a compact and affordable device.

### NEW-GENERATION IMAGE PROCESSING

The Color imageRUNNER C2550 device is powered by Canon's revolutionary imageCHIP system architecture. This not only enables simultaneous copying, printing, scanning, sending, and faxing, but it will change the way you think about using color in your office.

### SUPERIOR PRINT PERFORMANCE

For network printing with impressive results, this device includes the UFR II print controller as standard. The UFR II (Ultra Fast Rendering) language is optimized to facilitate high-speed color printing by distributing the data processing between the print driver on the user's desktop computer and the controller. The embedded controller also offers options for 1200-dpi printing, PCL, XPS,\* and PostScript 3 emulation support.

### IMAGE QUALITY OPTIMIZATION

Canon has developed technologies that improve the image quality and performance of Color imageRUNNER devices. Advanced Smoothing Technology (AST) increases image quality by smoothing the edges of all printed text and graphics. The Enhanced Resolution System (ERS) optimizes print performance by accelerating the rasterization of 1200-dpi print data.\*\*

imageCHIP System Architecture



### SPACE-SAVING DOCUMENT PRODUCTION

The Color imageRUNNER C2550 device supports the optional Internal Finisher-Z1, which can corner or double-staple multi-page documents without increasing the footprint of the device. There's also the Inner 2-Way Tray option, which can provide dual paths for output, providing separation of copies, prints, or faxes.



Finisher-Z1

\* Check with your Authorized Canon Dealer for availability.

\*\* Requires optional 1200-dpi Printer Expansion Board-A1.

## FAST COPYING AND SCANNING

Copy operations are greatly simplified through the choice of two user interfaces. The standard copy display simplifies operations for novice users, while an Express Copy menu provides advanced users quick access to various copying modes on a single screen. With the optional 50-sheet Duplexing Automatic Document Feeder (DADF) accessory, you can scan/copy documents at up to 44 impressions per minute (ipm) at 300 dpi in black and white or color.

Express Copy Screen

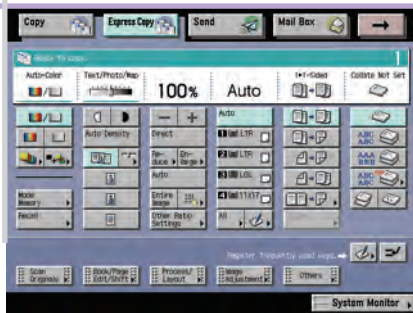

## COMPLEX JOBS MADE SIMPLE

The Color imageRUNNER C2550 device makes the production of complicated documents manageable. Users can combine different sets of documents into one with Job Block Combination at the device. Each set can be configured to run with unique settings, such as paper type, finishing, color, and more, then reproduced or stored as a new document in a Mail Box. From the desktop, individual pages or groups of pages in documents can be configured with the new Exceptional Settings feature\* in the print driver to control output settings such as media type, paper size, input tray, and finishing options.

## DIGITAL DYNAMICS

Adding digital data to copies and prints is easy and powerful. Create ad hoc watermarks, select preset stamps, add page and copy set numbering, and/or date stamping to any output with control over size, position, colors, and density. You can also embed secure watermarks that appear when copies are made to help prevent security leaks of confidential information.

Secure Watermark



## WIRELESS LAN CONNECTIVITY

Using the Canon Wireless LAN option with the Color imageRUNNER C2550 device gives you the latest in wireless technology for connecting to a Local Area Network. Supported standards include 802.11g and 802.11b for up to 54 Mbps and 11 Mbps transmission speeds, respectively, and compliance with WPA, WEP, and WEP2 security encryption.

Wireless LAN Kit

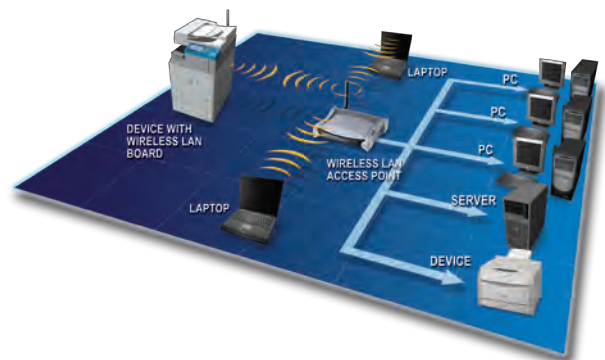

\* Requires PCL Printer Kit-Q3 and PS Printer Kit-Q3 options.

# SUPERIOR COMMUNICATION

## Enhance your digital world with Color Universal Send

With Canon's proprietary Color Universal Send technology standard, the Color imageRUNNER C2550 device enables you to distribute scanned documents to multiple network destinations—such as e-mail and Internet fax addresses, local Mail Boxes, fax, network folders, and WebDAV services—in one simple operation. Quickly and easily send documents to user addresses in a local Address Book, look up users from multiple LDAP servers on your network, or manually enter a destination.

Color Universal Send offers powerful options to master the creation, distribution, and archiving of your documents. The PDF Advanced Feature Set option provides additional functionality such as PDF High Compression, Trace & Smooth PDF, and Searchable PDF modes.

### PDF HIGH COMPRESSION TECHNOLOGY

Canon's proprietary PDF High Compression Mode makes more efficient use of your network and storage resources by significantly reducing the size of PDF files. And with the exclusive Trace & Smooth PDF feature, text in PDF files can be converted to outlines for sharper edges and increased readability. The outline data can also be manipulated in Adobe® Illustrator® to create elements for other documents.

Universal Send



Universal Send Main Screen

### CREATING SEARCHABLE PDF DOCUMENTS

After scanning for PDF creation, the text is then embedded within the file for extraction or keyword searches with the Searchable PDF feature. This allows you to easily scan and convert scanned documents into your electronic workflow.

#### FILE SIZE COMPARISON

Original: Letter-Sized Hard Copy (Color Graphics with Text)



Canon's PDF (Compact)  
300-dpi Color Scan  
File Size: 150 KB

PDF File Format  
300-dpi Color Scan  
File Size: 2 MB

PDF File Format  
300-dpi B/W Scan  
File Size: 390 KB



PDF High Compression Mode

Trace & Smooth PDF Mode

### HIGH-VOLUME FAX CAPABILITY

The Color imageRUNNER C2550 device supports the option to add a single- or multi-line Super G3 fax module to further extend the capabilities of Color Universal Send. Incoming faxes can also be automatically routed to other devices, destinations, or users with the Job Forwarding feature for superior workflow management.

### ADVANCED WORKGROUP COLLABORATION

Each device includes internal Mail Boxes for document storage and print-on-demand applications. Documents can be combined and printed as a single job or sent to multiple destinations in a variety of formats. For files that are too large for e-mail or require a large distribution list, the URL Send feature can e-mail a link to notify recipients that they can remotely preview via PC and, if necessary, print from the device.

### DESKTOP INTEGRATION

The Color imageRUNNER C2550 device is designed to work seamlessly with Canon's imageWARE™ Document Manager Personal as a total end-to-end document solution, enhancing the integration between your workspace and the device.

### MAXIMIZE THE POWER OF THE WEB

Provide more ways to share information with the world beyond your office than ever before. With the industry's first Web Access Software option, you can browse the Web or corporate intranets directly from the device's color touch-panel display and even print Web pages or PDF files from the Internet or your network without a computer.\* Color Universal Send also supports the Web-based Distributed Authoring and Versioning (WebDAV) protocol to securely share documents over the Internet, enabling users to collaborate on documents whether they're in the office, on the road, or at home for increased productivity.



Mail Box Screen

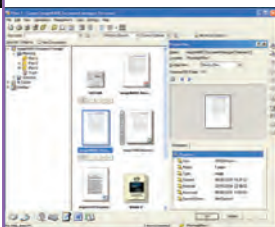
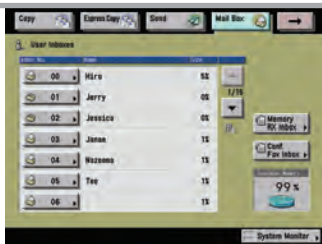

imageWARE Document Manager Personal

Web Access Software

\* Requires Web Access Software-E1 and PS Printer Kit-Q3 if printing PDF files.

## SCALABILITY

### OPEN PLATFORM INTEGRATION

Canon's Java-based MEAP architecture lets you design custom interfaces and applications to run on the Color touch-panel of the Color imageRUNNER C2550 device. MEAP applications can be easily created to support customized workflows for the seamless integration of your business processes.

### POWERFUL DOCUMENT MANAGEMENT

Canon offers industry-leading solutions for effective production, archiving, and retrieval of critical business documents. Canon's imageWARE Publishing Manager software can create documents comprised from many different sources and applications using a simple drag-and-drop interface. And Canon's optional imageWARE Document Manager software enables you to efficiently store vast amounts of information in a centralized electronic repository for easy, secure, and effective document management.



imageWARE Publishing Manager

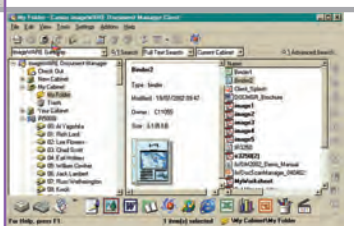

imageWARE Document Manager



eCopy ShareScan

### OPERATIONAL EFFICIENCY

Breeze through complex tasks and help to reduce operator mistakes using the new Workflow Composer option. Workflow Composer enables users to configure one-button to perform multiple actions, such as copying, sending, and storing at the device in a single step. For even greater convenience, workflow buttons can also be created and edited from the desktop.



Workflow Composer Screen



## USER-FRIENDLY

### Simplicity for users

For users, the Color imageRUNNER C2550 device facilitates operations with its easy-to-read, full-color touch-panel, interactive help menus, insightful documentation and tutorials, and remote operation capabilities. Powerful features for user access/privileges and device management help streamline administration.



Control Panel

### SUPPORT TOOLS FOR OPERATORS

The Easy Operation Guide provides step-by-step instructions on how to operate the main functions while the [Help] hard key on the device provides instructions and explanations. The user manuals are CD-based and feature search tools to find answers quickly and easily. User tutorials in Macromedia® Flash® format are also available and can be distributed through your network or corporate intranet for smooth deployment.

### REMOTE UI (USER INTERFACE)

The Color imageRUNNER C2550 device can be accessed through a Web browser from any computer on the network. The Remote UI utility provides the ability to check the status of the device, track the progress of current jobs, monitor paper and toner levels, administer the Mail Box, and edit the Address Book.



Easy Operation Guide and Tutorial CD

### ...and for administrators

### FLEXIBLE USER ADMINISTRATION

Administrators can choose their method for controlling access and privileges to the Color imageRUNNER C2550 device. Authentication schemes include Single Sign-On (SSO) using network accounts, Simple Device Log-In (SDL), and Department ID Mode with optional Control Card/Card Reader system. Using the Access Management System, administrators have powerful control over access to the Color imageRUNNER C2550 Series device and its functions for even greater security and cost control—at both the user- and group-level.

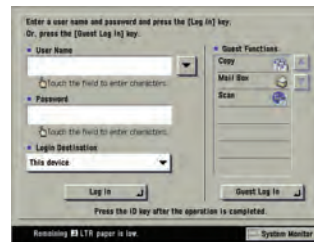

Access Management System Screen

### COMPREHENSIVE DEVICE MANAGEMENT

Canon's imageWARE Enterprise Management Console (EMC) is a Web-based utility that facilitates centralized management of networked devices. Built upon an extensible framework, it enables remote management of device settings, discovery of new devices using automated tasks, and device error notifications via e-mail. Administrators can also easily replicate settings and Address Books across multiple devices through the Device Information Delivery Function (DIDF), and push-print drivers to PC-based desktop computers for rapid deployment.

### Help Key



imageWARE Enterprise Management Console

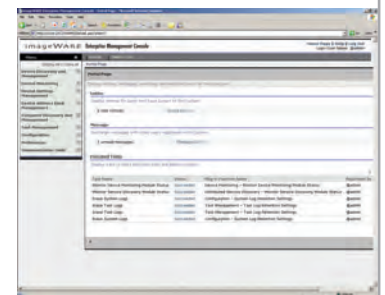

# SECURITY AND ACCESSIBILITY

## DEVICE ACCESS AND DATA SECURITY

The Color imageRUNNER C2550 device includes features to help you guard against unauthorized access to the device and its data. In addition to user-level authentication, it can also restrict access from the network. The device also supports IP v6 for enhanced network infrastructure management. To protect your stored, scanned, and printed data, the HDD Data Erase option permanently removes deleted files by overwriting them up to three times. The HDD Data Encryption option provides additional security by encrypting data before it is written to the hard disk drive, and has achieved Common Criteria (CC) certification.

**Document Security**  
 Encrypted Secured Print  
 Watermark/Secure Watermark  
 Copy Set Numbering  
 Encrypted PDF  
 Digital Signature PDF  
 FAX Forwarding  
 FAX Destination Confirmation

**Mail Server Security**  
 POP Authentication before SMTP  
 SMTP Authentication

**Network Security**  
 MAC Address Filtering  
 IP Address Filtering  
 SSL Encryption  
 Network Application On/Off  
 USB Block  
 Destination Restriction

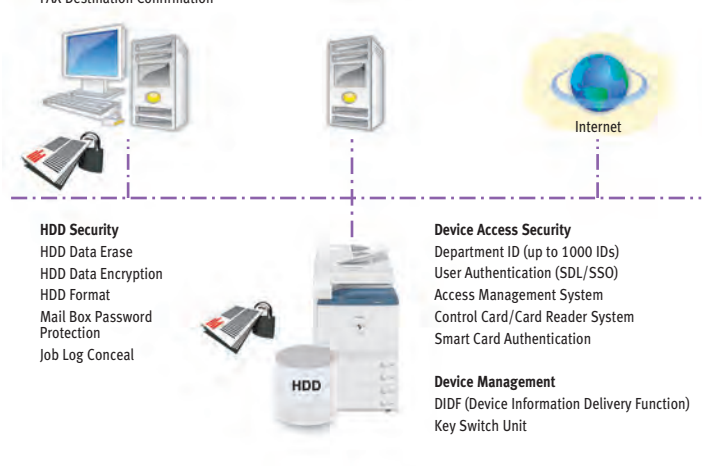

Device Management and Security Overview



Digital Signature PDF



Voice Operation Kit



Encrypted Secured Print Screen

## DOCUMENT SECURITY

The optional Universal Send PDF Security Feature-Set can help prevent impersonation or interception of your documents. Digital Device Signature mode and optional Digital User Signature mode provide verification of a document's source. You can also password-protect your documents with the Encrypted PDF feature, and securely print them over the network using the Encrypted Secured Print feature.

## ACCESSIBILITY

Canon offers solutions that go even further to ensure access for every authorized user of the Color imageRUNNER C2550 model. The device can be controlled with spoken commands using the Voice Operation Kit, the first Canon release of its kind for the U.S. market. This provides speech synthesis and voice recognition for individuals who are blind or have poor vision or mobility/dexterity impairments.

# SPECIFICATIONS



<b>MAIN UNIT</b>		<b>Installation Space (W x D):</b> 34" x 29-3/4" (when the Stack Bypass is extended)		<b>Communication Protocol</b>	
<b>Type:</b>	Color Digital Multifunction Imaging System	<b>Weight:</b>	Approximately 256 lb. (116kg Main Unit) Approximately 275 lb. (125kg with DADF)	<b>File:</b>	FTP (TCP/IP), SMB (TCP/IP), NCP (IPX), WebDAV
<b>Copying Method:</b>	Laser Dry Electrostatic Transfer	<b>Power Requirements:</b>	120V AC, 60Hz, 15A	<b>E-mail/I-fax:</b>	SMTP, POP3, I-fax (Simple, Full)
<b>Developing System:</b>	Dry Dual Component Developing System	<b>Power Consumption:</b>	1,500W	<b>Data Format</b>	
<b>Memory:</b>	Standard 1GB RAM Maximum 1.5GB RAM	<b>Plug:</b>	NEMA 5-15P	<b>File, E-mail:</b>	TIFF, JPEG, PDF, PDF (Compact),** PDF (Trace & Smooth),** PDF (OCR),** Encrypted PDF,*** Digital Signature PDF (Device,*** User*)
<b>Hard Disk Drive:</b>	80GB	<b>Toner (Estimated Yield):</b>	Black: 26,000 Images @ 5% Coverage Color: 14,000 Images @ 5% Coverage	<b>I-fax:</b>	B/W: TIFF (MH, MR, MMR) Color: TIFF (Profile-C)
<b>Network Interface Connections:</b>	10/100Base-TX (RJ-45)	<b>Copy Features</b>		<b>OPTIONAL ACCESSORIES</b>	
<b>Other Interface:</b>	USB 2.0 (Device), USB 2.0 (Host)	<b>Multiple Copies:</b>	1 to 999	<b>Super G3 Fax Board-W2/Super G3 Multi-Line Fax Board-J2</b>	
<b>First-Copy Time:</b>	8.9 Seconds (Color) 5.9 Seconds (B/W)	<b>Max. Copy Reservation:</b>	10 Jobs	<b>Applicable Line:</b> Public Switched Telephone Network (PSTN)	
<b>Warm-Up Time:</b>	38-Seconds After Powering On	<b>Color Mode:</b>	Auto Color, Full Color, Black, Single Color, Two Colors	<b>Connection Lines:</b> One-Line (Super G3 Fax Board W2), Two-Lines (Super G3 Multi-Line Fax Board-J2)	
<b>Copy/Print Speed (B/W, Color):</b>	25/23 ppm (Letter)	<b>Copy Exposure:</b>	Automatic or Manual (9 Levels)	<b>Sending/Original Size:</b> Statement to 11" x 17"	
<b>Scan Resolution:</b>	600 dpi x 600 dpi	<b>Magnification</b>		<b>Recording/Printing Size:</b> Statement to 11" x 17"	
<b>Copy Resolution:</b>	600 dpi x 600 dpi	<b>Preset Reduction:</b>	25%, 50%, 64%, 73%, 78%	<b>PCL Printer Kit-Q3**</b>	
<b>Engine Resolution:</b>	1200 dpi x 1200 dpi (Optional)*	<b>Preset Enlargement:</b>	121%, 129%, 200%, 400%	<b>CPU:</b> Canon Dual Custom Processor (Shared)	
<b>Halftone:</b>	256 Gradations (Continuous-Tone)	<b>Zoom Mode:</b>	25% - 400% (1% Increments)	<b>Memory:</b> 1GB RAM (Standard) 1.5GB RAM (Maximum) (Shared)	
<b>Paper Sources</b>		<b>Print Features</b>		<b>Hard Disk Drive:</b> 80GB (Shared)	
<b>Standard:</b>	Dual 550-Sheet x 2 Paper Cassettes 50-Sheet Stack Bypass	<b>CPU:</b>	Canon Dual Custom Processor (Shared)	<b>Supported PDL:</b> PCL 5c/6	
<b>Optional:</b>	Dual 550-Sheet x 2 Paper Cassettes 2,700-Sheet Paper Deck	<b>Memory:</b>	1GB RAM (Standard) 1.5GB RAM (Maximum) (Shared)	<b>Optional PDL Support:</b> PostScript 3 Emulation (PS Printer Kit-Q3***)	
<b>Maximum:</b>	4,950 Sheets	<b>Hard Disk Drive:</b>	80GB (Shared)	<b>Print Resolution</b>	
<b>Paper Sizes</b>		<b>Print Resolution</b>		<b>PCL 5c:</b> 600 dpi x 600 dpi 2400 dpi equivalent x 600 dpi	
<b>Cassettes:</b>	12" x 18",** 11" x 17",** Legal, Letter, Letter-R, Statement-R, Executive	<b>UFR II:</b>	600 dpi x 600 dpi 1200 dpi x 1200 dpi (Optional)* 2400 dpi equivalent x 600 dpi	<b>PCL 6:</b> 1200 dpi x 1200 dpi (Optional)* 2400 dpi equivalent x 600 dpi	
<b>Bypass:</b>	12-5/8" x 17-11/16", 12" x 18", 11" x 17", Legal, Letter, Letter-R, Statement, Statement-R, Executive, Irregular size (3-7/8" x 5-9/16" to 12-5/8" x 18"), and Envelopes	<b>Printer Driver</b>		<b>PS3 (Optional):</b> 1200 dpi x 1200 dpi (Optional)* 2400 dpi equivalent x 600 dpi	
<b>Acceptable Paper Weight</b>		<b>UFR II:</b>	Windows® (Windows 2000/XP/Server 2003/Windows Vista®) Citrix MetaFrame Macintosh® (OS 10.2.8 or later)	<b>Printer Drivers</b>	
<b>Cassettes:</b>	17 lb. Bond to 90 lb. Index	<b>XPS:*</b>	Windows Vista	<b>PCL 5c:</b> Windows (Windows 2000/XP/Server 2003/Windows Vista) Citrix MetaFrame	
<b>Bypass:</b>	17 lb. Bond to 110 lb. Index	<b>Mail Box Features</b>		<b>PCL 6:</b> Windows (Windows 2000/XP/Server 2003/Windows Vista) Citrix MetaFrame Macintosh (OS 10.2.8 or later)	
<b>Duplexing:</b>	Standard Automatic Trayless Duplexing (Executive to 12" x 18")	<b>Max. Mail Boxes Supported:</b>	100 User Inboxes, One Memory RX Inbox, 50 Confidential Fax Inboxes	<b>PS3 (Optional):</b> Windows (Windows 2000/XP/Server 2003/Windows Vista) Citrix MetaFrame Macintosh (OS 10.2.8 or later)	
<b>Image Reader:</b>	Color Image Reader-L1 (Standard)	<b>Scan Features</b>		<b>Cassette Feeding Unit-Y3</b>	
<b>Acceptable Originals:</b>	Sheet, Book, 3-Dimensional Objects (Up to 4.4 lb.)	<b>Network TWAIN Scan:</b>	Standard	<b>Paper Sizes:</b> 12" x 18", 11" x 17", Legal, Letter, Letter-R, Statement-R, Executive	
<b>Maximum Original Size:</b>	11" x 17"	<b>Network Scan Utility:</b>	Color Network ScanGear	<b>Paper Drawers Capacity:</b> 550-Sheet x 2 Cassettes [20 lb. Bond (80 g/m³)]	
<b>Document Feeding Method:</b>	Duplexing Automatic Document Feeder (Optional)	<b>Color Universal Send Features</b>		<b>Dimensions (H x W x D):</b> 9-7/8" x 22-1/4" x 27-5/8"	
<b>Acceptable Originals:</b>	Statement to 11" x 17"	<b>Color Mode:</b>	Auto Color Select (Full Color/Grayscale) Auto Color Select (Full Color, B/W) Full Color, Grayscale, B/W	<b>Weight:</b> Approximately 50.7 lb. (23kg)	
<b>Paper Capacity:</b>	50 Sheets	<b>Address Book Capacity:</b>	Max. 1,800 Destinations (Includes 200 One-Touch Buttons) Max. 5 LDAP Servers	<b>Paper Deck-Z1</b>	
<b>Acceptable Paper Weight of Originals:</b>	Simplex 11 lb. to 32 lb. Bond (42 to 128 g/m³) Duplex 13 lb. to 32 lb. Bond (50 to 128 g/m³)	<b>Sending Methods:</b>	E-mail, I-fax, SMB, File Server (FTP, IPX, WebDAV), User Inbox, Super G3 Fax (Optional)	<b>Paper Size:</b> Letter	
<b>Scan Speed:</b>	44 ipm (300 dpi) 28 ipm (600 dpi)			<b>Paper Deck Capacity:</b> 2,700 Sheets [20 lb. Bond (80g/m³)]	
<b>Dimensions (H x W x D):</b>	31-1/8" x 22-1/4" x 29-3/4" (Main Unit) 36" x 22-1/4" x 29-3/4" (with DADF)			<b>Dimensions (H x W x D):</b> 18-5/8" x 14-5/8" x 23-1/4"	

### Finisher-Z1

Number of Trays:	One Tray
Paper Size	
Standard:	12-5/8" x 17-11/16", 12" x 18", 11" x 17", Legal, Letter, Letter-R, Statement, Statement-R, Envelopes (COM10 No. 10, Monarch, DL, ISO-B5, ISO-C5, Yougata 4, Catalog Glove No.8)
Non-Standard Size:	3-7/8" x 5-9/16" to 12-5/8" x 18"
Paper Weight:	17 lb. Bond to 80 lb. Cover
Paper Capacity Per Tray:	500 Sheets (Letter, Statement, Statement-R) or 2-3/4" in Height
	250 Sheets (11" x 17", Legal, Letter-R) or 1-3/8" in Height
Paper Capacity of Staple Mode:	
	500 Sheets/30 Sets (Letter) or 2-3/4" in Height
	250 Sheets/30 Sets (11" x 17", Legal, Letter-R) or 1-3/8" in Height
	500 Sheets/30 Sets (Staple Mode with Different Paper Sizes) or 2-3/4" in Height
Max. Stapling Capacity	
Letter:	50 Sheets (17 lb. to 20 lb. Bond) 30 Sheets (20 lb. to 28 lb. Bond) 2 Sheets (32 lb. Bond to 90 lb. Index)
11" x 17", Legal, Letter-R:	30 Sheets (17 lb. to 20 lb. Bond) 20 Sheets (20 lb. to 28 lb. Bond) 2 Sheets (32 lb. Bond to 90 lb. Index)
Staple Mode:	Corner (11" x 17", Legal, Letter, Letter-R)
	Double (11" x 17", Letter)
Dimensions (H x W x D):	8-1/2" x 27-3/8" x 21-5/8"

### Inner 2-Way Tray-D1

Paper Size	
Standard:	12-5/8" x 17-11/16", 12" x 18", 11" x 17", Legal, Letter, Letter-R, Statement, Statement-R, Executive
Non-Standard:	3-7/8" x 5-9/16" to 12-5/8" x 18"
Max. Paper Weight:	17 lb. Bond to 80 lb. Cover
Paper Capacity Per Tray	
Upper Output Tray:	100 Sheets (Letter) 50 Sheets (Other Sizes)
Lower Output Tray:	250 Sheets (Letter) 100 Sheets (Other Sizes)
Dimensions (H x W x D):	6" x 7" x 21-1/2"

### OTHER OPTIONAL ACCESSORIES

- Encrypted Secured Print Software-C1\*
- Barcode Printing Kit-A1\*
- Web Access Software-E1\*
- Universal Send PDF Advanced Feature-Set-A1
- Universal Send PDF Security Feature-Set-A1
- Digital User Signature PDF Kit-A1
- Secure Watermark-A1\*\*\*
- Super G3 Fax Board-W2
- Super G3 Multiline Fax Board-J2
- iR 512MB Expansion RAM-C1
- HDD Data Erase Kit-A1
- HDD Data Encryption Kit-B1
- Voice Guidance Kit-B1<sup>o</sup>
- Voice Operation Kit-A1<sup>o</sup>
- Remote Operator's Software Kit-A2
- Platen Cover Type H
- Cabinet-P1
- Copy Tray-J1
- Envelope Feeder Attachment-C2
- FL Cassette-Y1
- FL Cassette-Z1

- Document Tray-J1
- Card Reader-C1
- Card Reader Kit-B1
- Key Switch Unit-A2
- Braille Label Kit-A1
- ADF Access Handle-A1
- Stamp Unit-A1
- eCopy Suite
- imageWARE™ Suite
- Access Management System Kit-A1
- Workflow Composer-B3
- Wireless Network Interface Adapter NB-W1
- 1200 dpi Printer Expansion Board-A1

- \* Requires 1200-dpi Printer Expansion Board-A1. If 1200-dpi print is selected, engine speed will slow down.
- \*\* Not available in top cassette.
- \* Check with your Authorized Canon Dealer for availability.
- \*\* Requires Universal Send PDF Advanced Feature-Set-A1.
- \*\*\* Requires Universal Send PDF Security Feature-Set-A1.
  - ▲ Requires Digital User Signature Kit-A1.
  - ▲▲ Color UFR II Printing is standard.
  - ▲▲▲ Requires imageRUNNER 512MB Expansion RAM-C1.
    - Requires PCL Printer Kit-Q3.
    - Requires PS Printer Kit-Q3 if printing PDF files.
    - Voice Guidance Kit-B1 and Voice Operation Kit-A1 cannot be installed together.

**Canon**  
image*ANYWARE*

As an ENERGY STAR® Partner, Canon U.S.A., Inc. has determined that this product meets the ENERGY STAR guidelines for energy efficiency. ENERGY STAR and the ENERGY STAR mark are registered U.S. marks. eCopy is a trademark of eCopy, Inc. Windows and Windows Vista are registered trademarks of Microsoft Corporation in the United States and/or other countries. Macintosh is a trademark of Apple Inc. Adobe and PostScript are registered trademarks or trademarks of Adobe Systems Incorporated in the United States and/or other countries. CANON, IMAGERUNNER, MEAP, and the GENUINE logo are registered trademarks of Canon Inc. in the United States and may also be registered trademarks or trademarks in other countries. IMAGEWARE is a registered trademark of Canon U.S.A., Inc. in the United States and is a trademark of Canon Inc. in certain other countries. IMAGEANYWARE is a trademark of Canon. All referenced product names and other marks are trademarks of their respective owners. Specifications and availability subject to change without notice. ©2010 Canon U.S.A., Inc. All rights reserved.

Federal Law prohibits copying of certain documents. Violators may be subject to penalties. We suggest that you check with your own legal counsel. Canon U.S.A., Inc. and Canon Canada, Inc. intend to cooperate with Law Enforcement Agencies in connection with claims of unauthorized copying.



1-800-OK-CANON  
www.usa.canon.com

Canon U.S.A., Inc.  
One Canon Plaza  
Lake Success, NY 11042

